

Enclosure Mounting Specifications

Ventev's Outdoor Power Solutions utilize various enclosure options, allowing system engineers to configure a solution that meets your exact needs. These NEMA 4X enclosures are used in our standard line and are made of either gray polycarbonate, powder-coated steel or powder-coated aluminum. Each enclosure includes an aluminum back plate, mounting feet and DIN rail for additional equipment installation.

Aluminum Enclosures

Small (18" x 16" x 10")

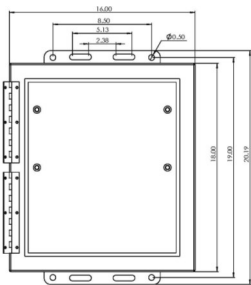

Medium (26" x 16" x 12")

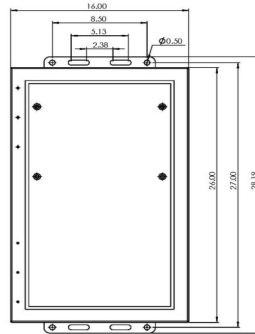

Large (26" x 27" x 12")

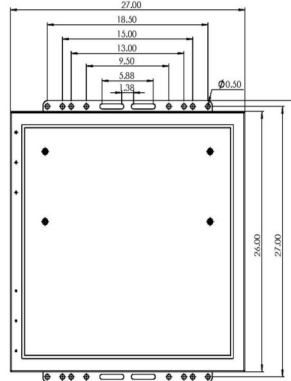

X-Large (40" x 27" x 13")

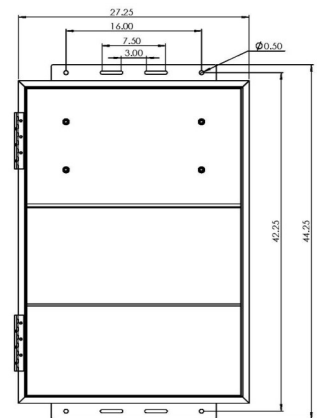

Polycarbonate Enclosures

Small (12" x 10" x 6")

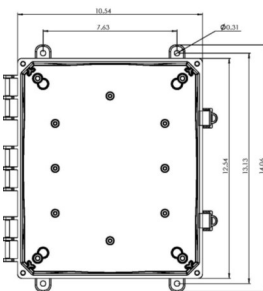

Medium (14" x 12" x 6")

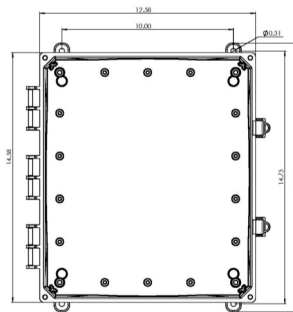

Large (18" x 16" x 10")

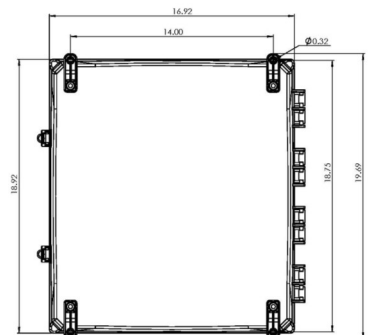

Steel Enclosures

Small (12" x 10" x 6")

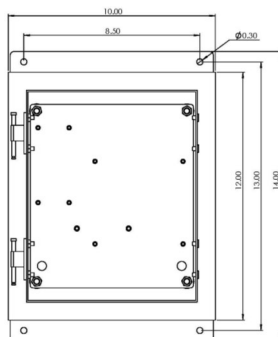

Medium (14" x 12" x 6")

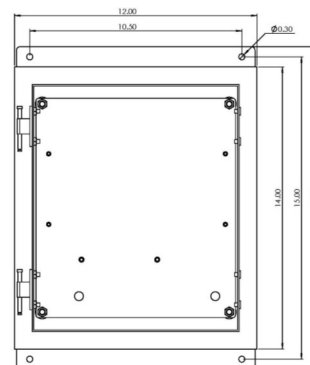

For project support contact a Ventev Regional Sales Executive.

800.851.4965 | TerraWave.com | sales@terrawave.com

Aluminum Enclosure Mounts

Small Aluminum Enclosure Mount
SKU 529706



Compatible with 18" x 16" Aluminum enclosure. Includes 3/8" hardware.

Utility Pole Mount
SKU 389792

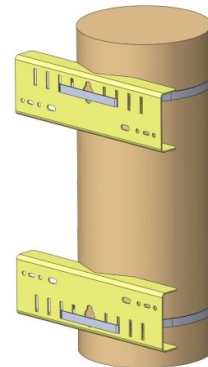

Compatible with all 18" x 16", 26" x 16" and 26" x 27" Aluminum enclosures. Fits up to a 13" diameter pole.

Polycarbonate Enclosure Mounts

Small / Medium Pole Mount Kit
SKU 303580



Compatible with all 12" x 10" and 14" x 12" Polycarbonate enclosures. Fits up to a 12" diameter pole.

Large Pole Mount Kit
SKU 339837



Compatible with 18" x 16" Polycarbonate enclosures. Fits up to a 12" diameter pole.

Extra Large Pole Mount Kit
SKU 500566



Compatible with 24" x 24" Polycarbonate enclosures. Fits up to a 12" diameter pole.

Additional Mounts

Solar Panel Adapter Kit
SKU 529705

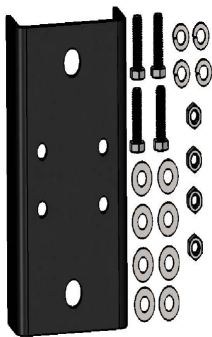

For mounting solar panels. Includes 3/8" hardware.

For project support contact a Ventev Regional Sales Executive.

800.851.4965 | TerraWave.com | sales@terrawave.com